

# UNITÉ #552

## PLAN D'AMÉNAGEMENT

3 CHAMBRES

SUPERFICIE: 1977 PI.CA.

APPENTIS: 110 PI.CA.

TOTAL: 2087 PI.CA.

TERRASSE: 536 PI.CA.

GRAND-TOTAL: 2623 PI.CA.

DATE: 2021-06-16

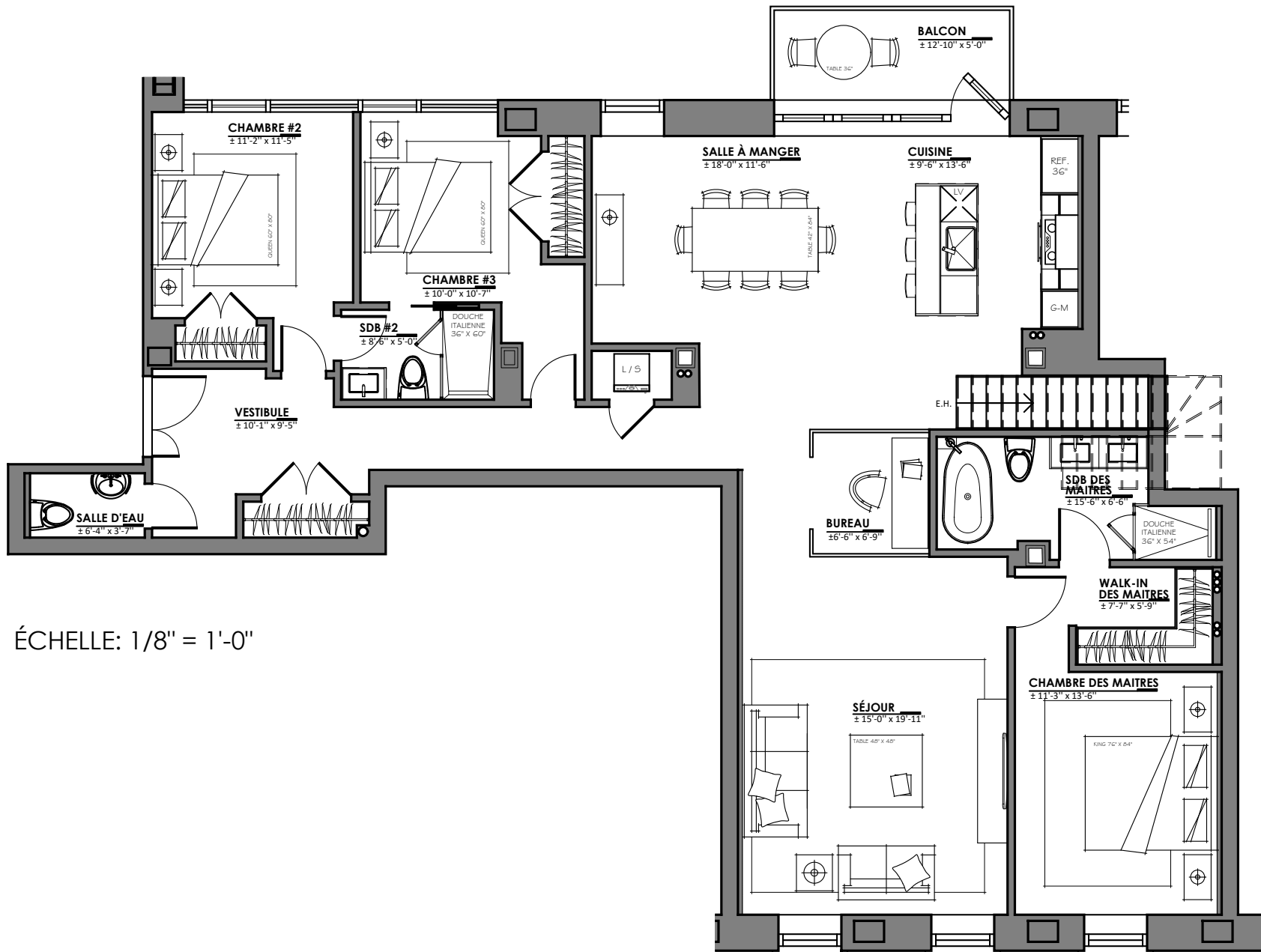

ÉCHELLE: 1/8" = 1'-0"

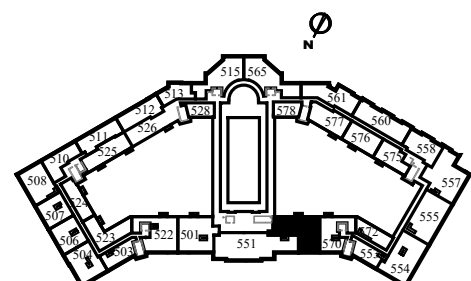
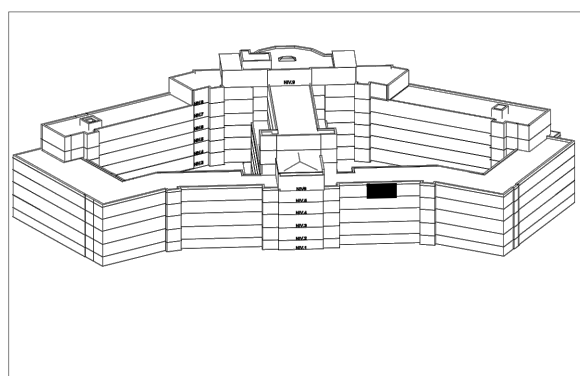

PLAN CLE / KEY PLAN  
PLAN PRÉLIMINAIRE. SUJET À CHANGEMENT SANS PRÉAVIS.  
SUPERFICIE BRUTE APPROXIMATIVE, À TITRE INDICATIF SEULEMENT.  
PRELIMINARY PLAN, SUBJECT TO CHANGE WITHOUT PRIOR NOTICE.  
APPROXIMATE SQUARE FOOTAGE, FOR INFORMATION PURPOSES ONLY.

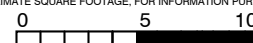

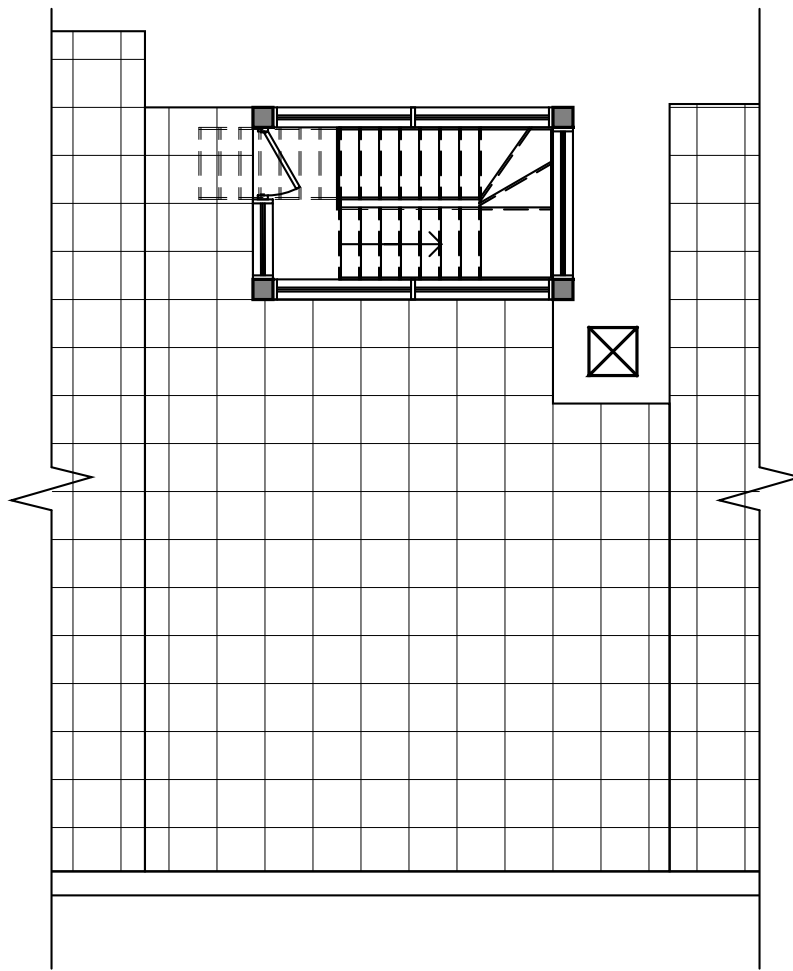

ÉCHELLE: 1/8" = 1'-0"

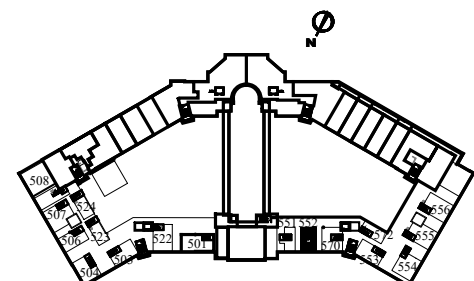
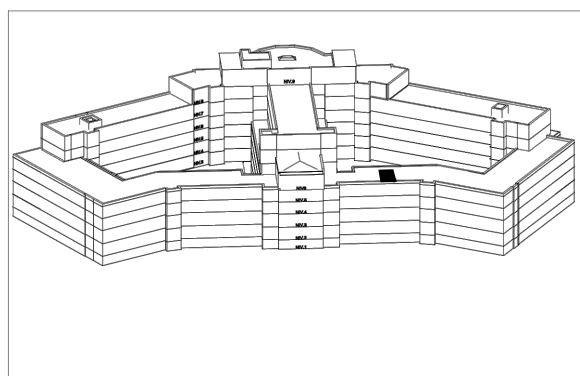

PLAN CLE / KEY PLAN  
 PLAN PRÉLIMINAIRE, SUJET À CHANGEMENT SANS PRÉAVIS.  
 SUPERFICIE BRUTE APPROXIMATIVE, À TITRE INDICATIF SEULEMENT.  
 PRELIMINARY PLAN, SUBJECT TO CHANGE WITHOUT PRIOR NOTICE.  
 APPROXIMATE SQUARE FOOTAGE, FOR INFORMATION PURPOSES ONLY.

0 5 10

**A2**